



INFRASTRUCTURE



COLUMN CLAMPS



FALSEWORK



TILT-UP

OUR CAPABILITIES

WELDING

- MIG Welding
- Stick Welding
- TIG Welding
- Stainless Steel & Stud
- Contracted Inspection Service

CUTTING

- CNC Plasma Cutting
- CNC Flame Cutting
- Saw Cutting

FABRICATION

- Shearing & Rolling
- Bending & Forming
- Threading & Tapering
- Drilling & Tapping

OTHER SERVICES

- Press Braking
- Roll Threading
- Punch Pressing
- Cut Threading - Coil, NC, Acme, Euro
- Paint, Powder Coat, & Galvanizing
- In-House AutoCAD Drafting
- CAD/CAM Software
- Heavy Steel Purchasing
- Blanchard Ground Plate
- Cold & Hot Heading
- Multi-Hole Drilling
- Heat Induction
- Grinding
- 10-ton Overhead Crane
- Plasma Marking
- Re-working Old & Damaged Parts
- Product Assembly



13407 YORBA AVE.
CHINO, CA 91710



P: (909) 590-0066
F: (909) 590-0061

PRODUCT LINE CARD

HEAVY WALL FORMING

- Battered Washers
- Beam Ends
- Bridge Overhang Brackets [28", 42"]
- Catheads [1/2", 3/4"]
- CL200 PVC Pipes [3/4", 1"]
- Coil Eye Nuts & Bolts
- Coil Bolts [1/2", 3/4", 1" DIA.]
- Coil Nuts STD/HVY
- Coil Rod Couplers
- Coil Wing Nuts
- Column Clamps [Econo-Type]
- Column Clamps [Scissor]
- D49 Overhang Brackets
- Edge of Deck Walkway Brackets
- Fit Up Bolts [3/4" x 2" & 4"]
- Fit Up Nuts [3/4"]
- Guard Rail Posts
- Hand Rail Posts
- Hi-Tensile Coil Rods
- Inner Rods Coil/N.C. Thread
- J-Bolts Coil/N.C. Thread
- Keyplates/ Threaded Plates
- Lackey Brackets
- Lift Plates [Single, Dual]
- Pencil Rods
- Pencil Rod Buttons
- Plate Washers
- Post Shores
- Pro Bar Stripping Bars
- Push-Fit Cones [3/4"]
- Reshore Springs
- Screed Holders
- Screw Jacks
- She-Bolts [3/4", 1-1/4", 1-1/2"]
- Shore Clamps and Jacks
- Steel Strongbacks
- Taper Ties
- Tapped Lag Bolts [3/4" x 5"]
- Tilt-Up Braces [D1, D4, D5, D8, D12]
- Welded Angle Brackets

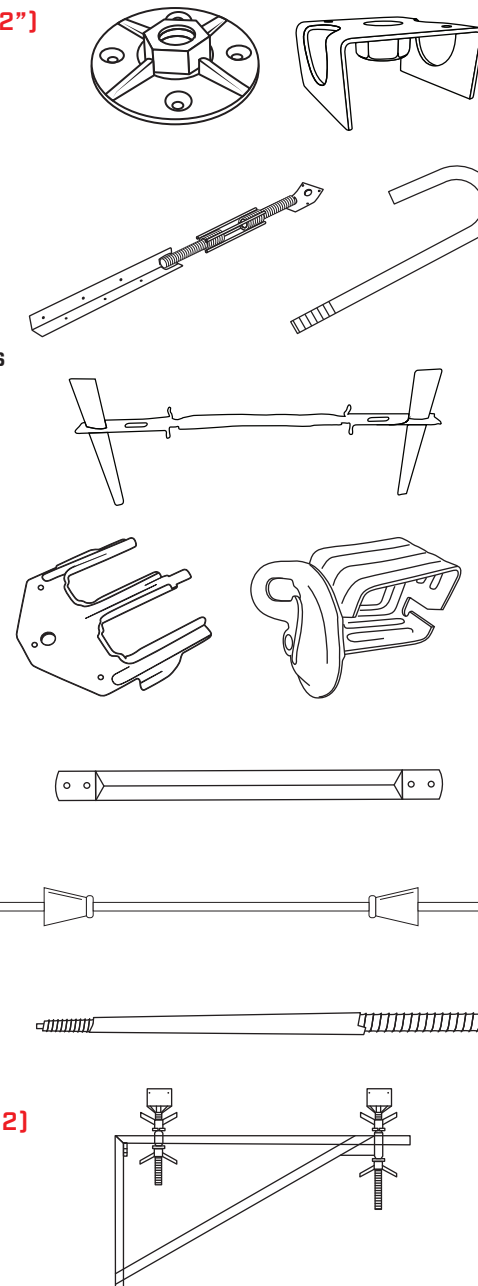

SLAB ON GRADE & FOOTING

- Aluminum Screed Pads
- Bolt Stands
- Curb Hooks [Ganchos]
- Flat Steel Stakes
- Footing Ties
- Header Form Brackets
- Nail Point Screed Pins
- Pipe Screed Brackets
- Pipe Screed Pin Caps
- Round Steel Stakes
- School Brackets
- 2x4 Screed Hooks, Bar
- Screed Posts w/ Base
- Screw Point Screed Pins
- Speed Clips
- Speed Screeds
- Stake Pullers
- Threaded Screed Pins
- Wedge Form Ties
- Wire Screed Hooks

LIGHT WALL FORMING

- "A" Brackets
- "C" Brackets
- Concrete Tie Hole Plugs [1"]
- Corner Locks
- Footing Ties
- Form Alignment Turnbuckles
- H.D. Snap Tie Wedges
- Liner Clamps
- Loop Ties
- Metal Hole Covers
- Plastic Tie Hole Plugs
- Scaffold Jacks
- Snap Brackets
- Snapties
- Snaptie Extenders
- Snaptie Wrenches
- Steel Rib Lath [Stayform]
- Waler Brackets [2x4, 2x6]
- Wall Spreaders
- Wall Panel Scaffold Brackets
- Wedge Bolts
- "X" Flat Ties

"The Best Choice for Concrete Accessories and Steel Fabrication"

CONCRETE ACCESSORIES

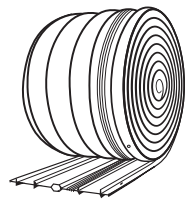

Bentonite Strip Waterstops
 Chamfer Cutters
 Custom Strip Reveals
 Dobies [1", 1.5", 2", 3", 6"]
 Hog Rings [#3]
 Hog Ring Pliers
 Hydrophilic Waterstops
 J-6 w/ Masonite Strips
 Neoprene Strips [1/8" x 12" x 50']
 PVC Waterstops
 Rosettes
 Tie Wire [16ga, 16.5 ga]
 TPV Waterstops
 W1-2 CDOT PVC Waterstops
 Waterstop Irons and Covers
 Wood Chamfers

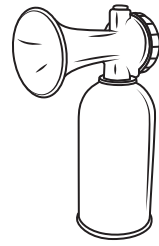

MISCELLANEOUS ACCESSORIES

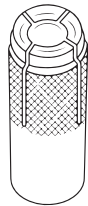

Coil Drop-In Anchors
 Coil Loop Inserts
 Conefast Cones
 Ferrule Loop Inserts
 Rumble Plates
 Setback Threaded Plugs [1"]
 Skip Boxes
 Smooth Steel Dowels
 Star Type Inserts [1/2", 5/8", 3/4"]
 STD Threaded Plugs [1/2", 5/8", 3/4"]

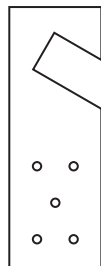
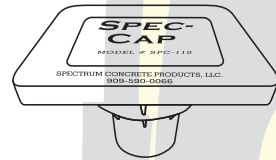

FALSEWORK ITEMS

Beam Clips [Janko's]
 Heavy C-Clamps
 Plate Clips
 Pre-Stress Brace Plates

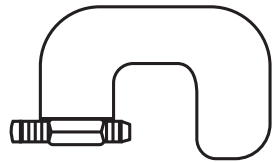

SAFETY PRODUCTS

3M Dust Masks
 3M Full Face Respirators
 3M Half Face Respirators
 3M Respirator Filters & Parts
 Air Horns
 Aprons
 Aware Wear
 Barricades [Type 1, 2, & 3]
 Blood Borne Pathogen Kits
 Caution Barrier Tape
 Danger Barrier Tape
 Delineators [42"]
 Disposable Coveralls
 Disposable Hair Covers
 Disposable Shoe Covers
 Ear Plugs & Ear Muffs
 Eye Wash Stations
 Faceshields and Replacement Lenses
 Gloves
 Hard Hats
 Hard Hat Winter Liners
 Jobsite Safety Signs
 New Hire Kits
 Rain Gear
 OSHA Rebar Caps
 Reflective Safety Cones
 Respirator Wipes
 Safety Glasses & Goggles
 Sweat Bands
 Welding Helmets

K-RAIL ITEMS

K-Rail Connecting Pins
 K-Rail Lifting Clamps
 K-Rail Lifting Hooks
 K-Rail Rebar Stakes CDOT

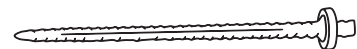

LAYOUT PRODUCTS

Chalk Bottles [1lb & 5lb] [Red, Blue, Black]
 Chalk Line
 Common Nails [600]
 Engineers Flagging
 Engineer's Tape [200' & 300']
 Felt-Tip Markers
 Folding Rule [6']
 Layout Tapes [100']
 Lumber Crayons
 Measuring Tapes
 Stake Chasers [Whiskers]
 Stringline
 Survey Grade Lath and Hubs
 Upsidedown Marking Paints

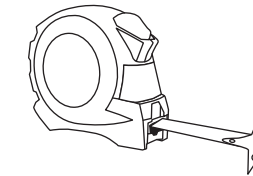
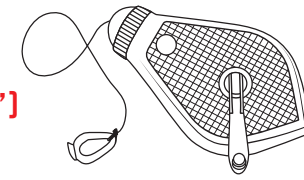

SWPPP ITEMS

Jute Netting
 Jute Staples
 Orange ESA Fence
 Orange Safety Fence
 Poly Sheeting
 Sandbags [Empty]
 Sandbags [Sand, Rock]
 Silt Fence [Black, Orange]
 Straw Bales
 Straw Wattles
 T-Posts [5' & 6']

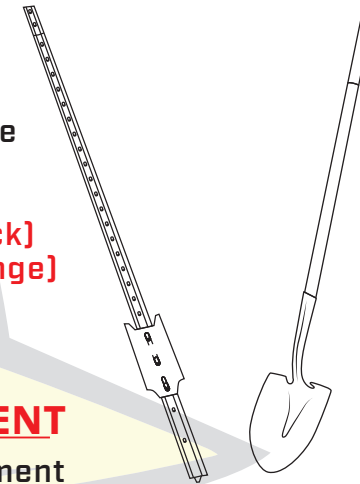

POWER EQUIPMENT

MQ Compaction Equipment
 MQ Concrete Screeds
 MQ Flex Shaft Vibrators
 MQ Hi-Cycle Vibrators/ Gens
 MQ Lighting Systems
 MQ Power Trowels
 MQ Pumps
 MQ Rebar Cutters/ Benders

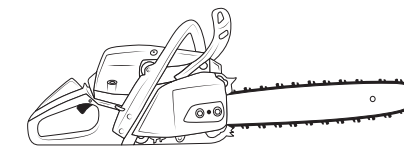

FASTENERS

6D Duplex Nails
 8D Duplex Nails
 16D Duplex Nails
 20D Duplex Nails
 8D GV Sinker Nails
 16D GV Sinker Nails
 60D BRT Common Nails
 3/4" Concrete Nails
 1" Concrete Nails
 3D Blue Lath Nails
 Simpson SET Epoxy
 Simpson Titan Bolts
 Simpson Strongbolt II
 Simpson Drop-In Anchors

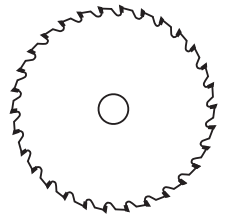

GEOSYNTHETICS

Drainage Composites
 Erosion/ Sediment Control
 Gabions
 Geogrids/ Geocells
 Geotextiles

FALL PROTECTION

Confined Space Tripods
 Fall Protection
 Fullbody Harness
 Lanyards
 Rebar Chain Positioners
 Rope Grabs
 Vertical & Horizontal Lifelines

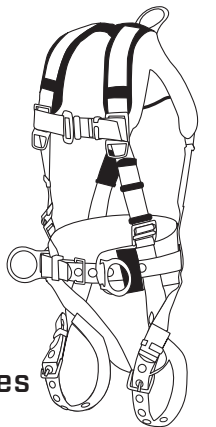

VENDORS

