

13407 YORBA AVE.  
CHINO, CA 91710



P: (909) 590-0066  
F: (909) 590-0061

MANUFACTURING • DISTRIBUTION • RENTALS

# SNAPTIES

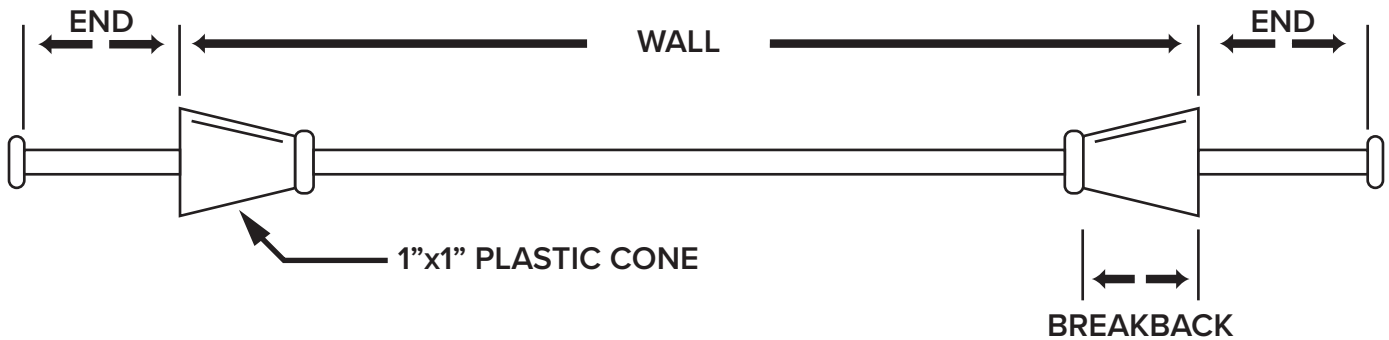

## SNAPTIE ACCESSORIES



SNAPTIE WEDGES

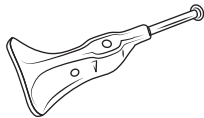

SNAPTIE EXTENDERS

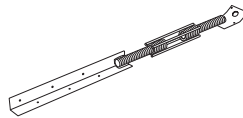

FORM ALIGNER BRACES



A-BRACKETS



C-BRACKETS

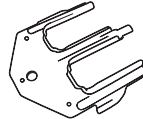

WATER BRACKETS

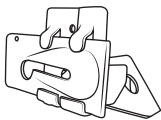

SNAP BRACKETS

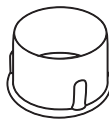

PUSH-IN PLASTIC PLUGS



CONCRETE PLUGS

## ATTRIBUTES

- 3M & High Strength
- Standard & Custom Lengths
- Round & Hex Heads
- Stainless Steel (3M)
- Neoprene & Metal Waterstop
- Various Cone Sizes
- Snaptie Forming Hardware Available

## POURED IN PLACE FORM

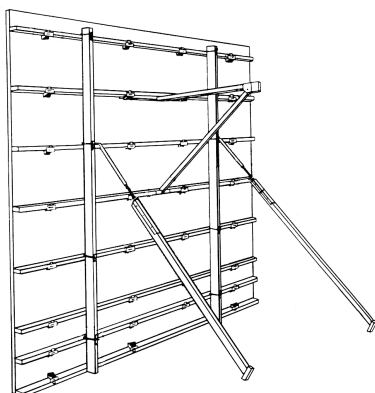

## TIE SPACINGS

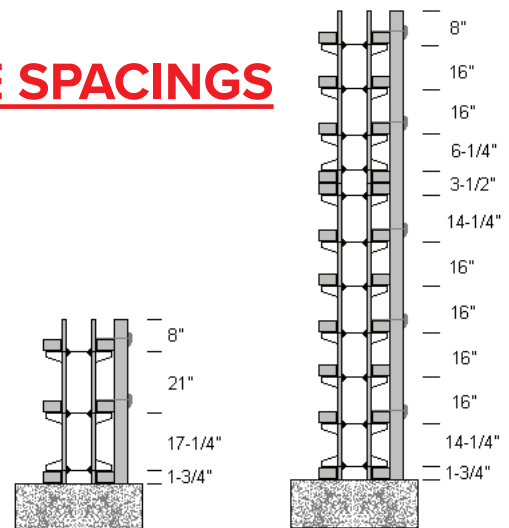

**“The Best Choice for Concrete Accessories and Steel Fabrication”**

# CUSTOM MADE SNAPTIES

## TIP TO TIP SNAPTIE



## WATERSEAL SNAPTIE



## THREADED SNAPTIE (REMOVABLE)



## SPANDREL POINT SNAPTIE



## SPANDREL HOOK SNAPTIE

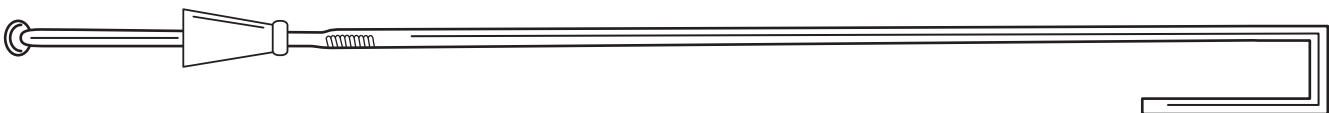

## BEAM TIE

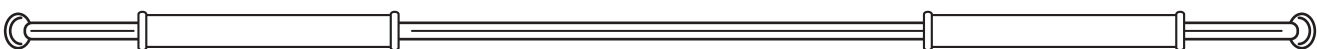

## STEEL RIB / STAYFORM TIE

